

ETD 29 - HORIZONTAL

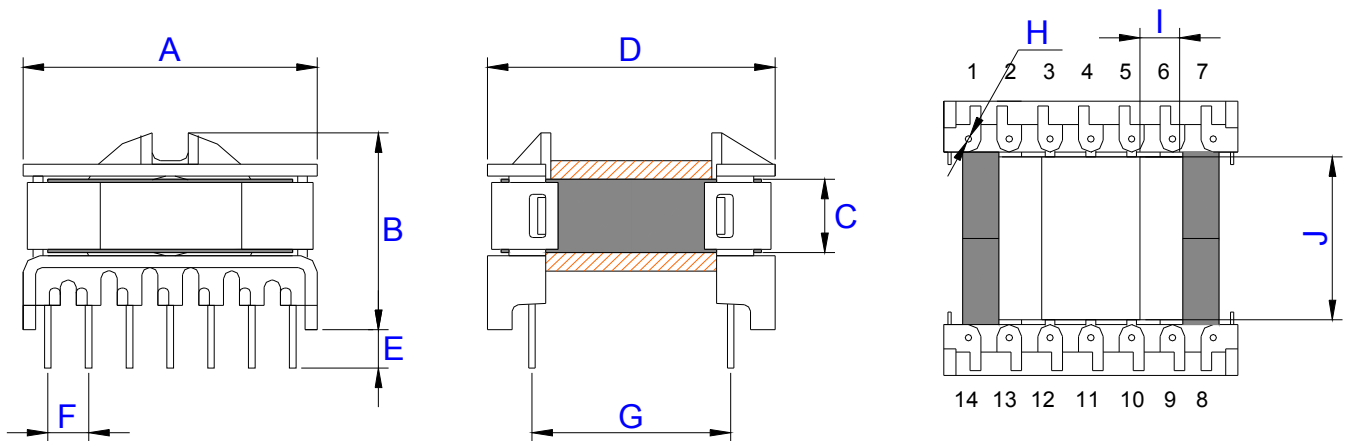

TOLERÂNCIA: +/- 0,5mm.

ÁREA ÚTIL DA JANELA: 55,5mm²

CARRETEL	A	B	C	D	E	F	G	H	I	J
ETD 29 - 14 pinos	35,5	25,5	9,6	35,2	5,0	5,0	25,6	0,8	4,8	19,3