

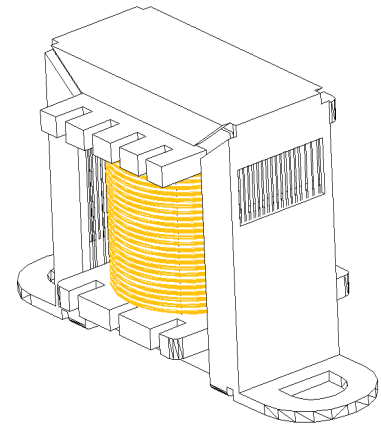

EI 28 ST CB

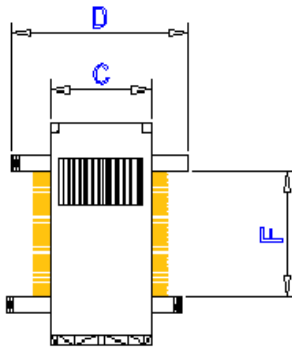
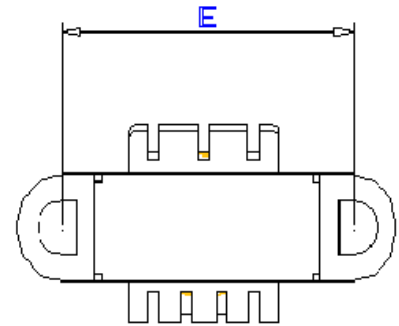
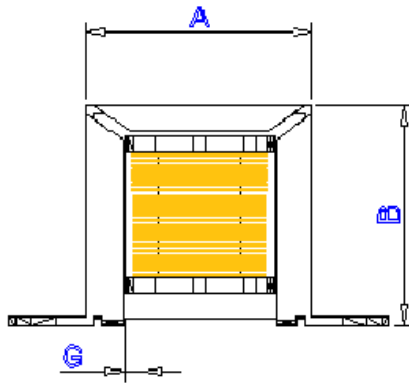

ÁREA ÚTIL DA JANELA: 46,8 mm²

TOLERÂNCIA: +/- 1,0 mm

CARRETEL	A	B	C	D	E
8,2 x 10,9 ST CB	29,4	26,6	13,0	22,4	39,2

POSSIBILIDADE: SEM ABRAÇADEIRA

CARRETEL	A	B	C	D	F	G
8,7 x 11,0 ST	28,3	25,2	11,1	22,4	15,0	5,2