

EI 48 ST CB2

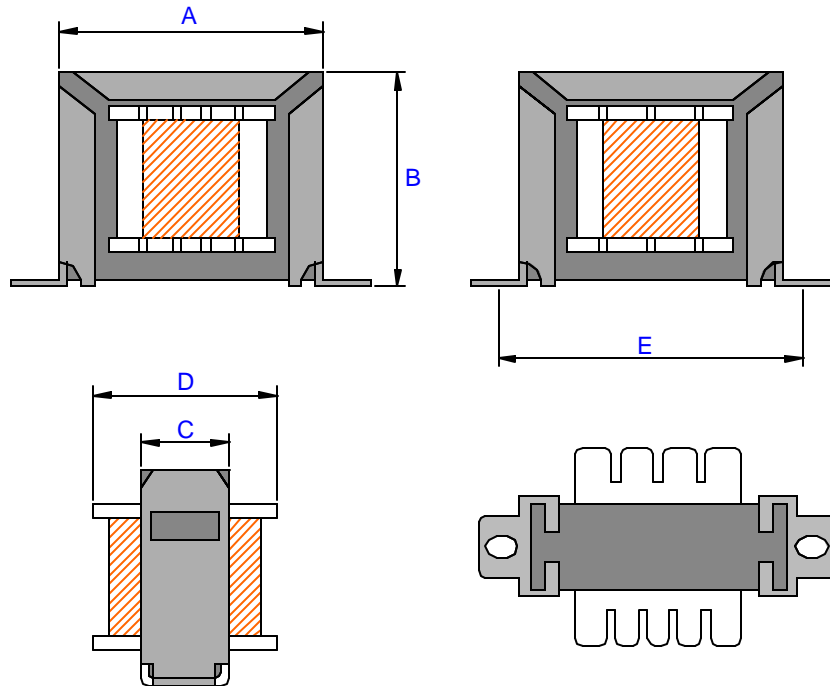

TOLERÂNCIA: +/- 1,0mm.

ÁREA ÚTIL DA JANELA: 64,5mm²

CARRETEL	A	B	C	D	E
16,8 x 16,4 ST CB	51,0	42,7	18,5	32,5	58,5

POSSIBILIDADE: SEM ABRAÇADEIRA

CARRETEL	A	B	C	D
16,8 x 16,4 ST	48,0	40,0	16,0	32,5